



Atim Cloud Wireless

Temperature & humidity monitoring

Cold room

User Guide



Modèles concernés :

ACW/LW8-TCR

ACW/SF8-TCR



Table of contents

DOCUMENT VERSION HISTORY	4
DISCLAIMER	4
TRADEMARKS AND COPYRIGHT	4
DECLARATION OF COMPLIANCE	5
ENVIRONMENTAL RECOMMENDATIONS	5
A. EXPLOSIVE ENVIRONMENT	5
B. ENVIRONMENT	5
A. RADIO	6
TECHNICAL SPECIFICATIONS	7
A. PRODUCT	7
B. SENSOR'S FUNCTIONS	7
HOUSING	8
A. SPACE REQUIREMENTS	8
B. INSTALLATION	8
C. IDENTIFICATION	10
OPERATING	11
A. OPERATING MODE	11
B. PRODUCT START UP	12
C. TEST FRAME EMISSION	13
D. DEEP SLEEP ENTRY	13
E. RADIO MODULE ACTIVITY	13
F. THRESHOLD EXCEEDED	13
G. ANTI-FRAUD SYSTEM	13
H. SUBSTITUTION TO THE MAGNET	13
I. BATTERY PASSIVATION	14
ACW CONFIGURATOR	15
A. COMPATIBLE CONFIGURATOR VERSION	15
B. CONFIGURATION DU ACW-TCR	16
<i>Emission period and samples in the frame</i>	16
<i>Keep alive frame period</i>	16
<i>Frame timestamp</i>	17
<i>Product's clock</i>	18
<i>Versions of the product</i>	18
<i>Sensor's configuration</i>	18
<i>Validation the configuration</i>	18
C. FACTORY SETTINGS	19
D. UPDATE ACWS	20
FRAMES' FORMAT	21
A. SIGFOX & LORAWAN	21
<i>Classic frame</i>	21
<i>The different type of frames</i>	22
<i>Measuring frame</i>	22
<i>Alert frame</i>	23
<i>Keep-alive frame</i>	24
<i>Error and alarm generic frame</i>	24
B. FRAMES' EXAMPLES	27
<i>Measurement frame</i>	27

<i>Alert frame measurement</i>	29
DOWNLINK	30
A. CONFIGURATION OF THE FRAME PARAMETERS (SENDING PERIOD, NUMBER OF SAMPLES, ETC.)	30
B. VIRTUAL PROBE CONFIGURATION	30
C. NUMBER OF PROBES	31
D. THRESHOLD CONFIGURATION	31
E. RESERVED CODES FOR FUTURES EVOLUTIONS	32
TECHNICAL SUPPORT	33

This user guide applies to the below product versions

	Product references	Product version (Visible on the product label)
LoRaWAN	ACW/LW8-TCR	A.0
Sigfox	ACW/SF8-TCR	A.0

Document version history

Version	Date	Description	Auteur	Concerned software version
0.1	02/06/2020	First document version	YLB	V0.0.1
0.2	12/11/2020	Keep alive frame description, add pairing mode, update error code table, update configurator images	AC	V0.0.1
0.3	10/12/2020	Downlink frame and datalogging description correction	AC	V0.0.1
1.0	07/05/2021	Casing modification	AC	V1.0.2
1.1	21/06/2021	Add guidance notes for samples sorting in periodic frame. Compatibility mode regarding repeaters LoRa/LoRaWAN and FSK/Sigfox description Modification of the operation mode description: LED behavior when searching for a network	AC	V1.0.2

Disclaimer

The information contained in this document is subject to change without warning and does not represent a commitment on the part of ATIM.

Trademarks and copyright

ATIM, ACW ATIM Cloud Wireless® and ARM Advanced Radio Modem® are registered trademarks of ATIM SARL in France. The other trademarks mentioned in this document are the property of their respective owners.

Declaration of compliance

All ACW Atim Cloud Wireless® products comply with the regulatory requirements of the R&TTE Directive (1999/5/EC), article 3:



1 SAFETY (Article 3.1a of the 1999/5/EC Directive)

NF EN60950-1 Ed. 2006/A1:2010/A11:2009/A12:2011 (health)

EN62479: 2010 (power <20mW) or EN62311:2008 (power > 20mW)

2 Electromagnetic Compatibility (Article 3.1b of the 1999/5/EC Directive)

EN 301489-3 v1.4.1, EN 301489-1 V1.9.2

3 Efficient use of the radio frequency spectrum (Art.3.2 of the 1999/5/EC Directive)

ETSI EN300 220-2 v2.4.1 and EN300 220-1 v2.4.1

Environmental recommendations

a. Explosive environment

Except for the ACW-ATEX range intended for this use, do not use ACW radio modems in the presence of flammable gas and smoke. The use of the equipment in this environment constitutes a danger.

b. Environment

Respect the temperature ranges for storage and operation of all products. Failing to respect these guidelines could disrupt device operation or damage the equipment.

Follow the instructions and warnings provided below to ensure your own safety and that of the environment and to protect your device from any potential damage.



General hazard – Failure to follow the instructions presents a risk of equipment damage.



Electrical hazard – Failure to follow the instructions presents a risk of electrocution and physical injury.



WARNING: do not install this equipment near any source of heat or any source of humidity.



WARNING: for your safety, it is essential that this equipment be switched off and disconnected from mains power before carrying out any technical operation on it.



WARNING: the safe operation of this product is ensured only when it is operated in accordance with its intended use. Maintenance may only be performed by qualified personnel.



Waste disposal by users in private households within the European Union. This symbol appears on a product or its packaging to indicate that the product may not be discarded with other household waste. Rather, it is your responsibility to dispose of this product by bringing it to a designated collection point for the recycling of electrical and electronic devices. Collection and recycling waste separately at the time you dispose of it helps to conserve natural resources and ensure a recycling process that respects human health and the environment. For more information on the recycling centre closest to your home, contact your closest local government office, your local waste management service or the business from which you purchased the product.

a. Radio

Modems in the ACW line are radio-communication modems that use the ISM (industrial, scientific and medical) bands, which may be used freely (at no cost and with no authorization required) for industrial, scientific and medical applications.

Technical specifications

a. Product

Dimensions	100 x 100 x 35 mm	
Antenna	Integrated (¼ of wave)	
Temperature probes	1 digital temperature and humidity probe (SHT35)	
Temperature	-40°C à +125°C (operating)	
	-40°C à +150°C (storage)	
Mounts to	Wall, tube or mast, DIN-Rail	
Casing	IP 65	
Power Supply	1 battery-packs [7,2 Ah]	
Weight	300 g	
Frequency	863 – 870 MHz	
Power	25 mW (14 dBm)	
Rate	Sigfox: 100 bits/s	
	LoRaWAN: 300 bit/s à 10 Kbit/s	
Consumption	Sigfox	LoRaWAN
Tx mode	60 mA	55 mA
IDLE	45 µA	45 µA
Rx mode	50 mA	25 mA

b. Sensor's functions

Temperature	Range	-40°C à +125 °C	
	Resolution	0,01°C	
	Accuracy from (operatic range)	-25°C to +70°C	+/- 0.2°C
Humidity	Range	0 à 100 %RH	
	Resolution	0,01 %RH	
	Accuracy from (operatic range)	-25°C to +70°C	+/- 2 %RH

Housing

a. Space requirements

MXN 100×100×35-50

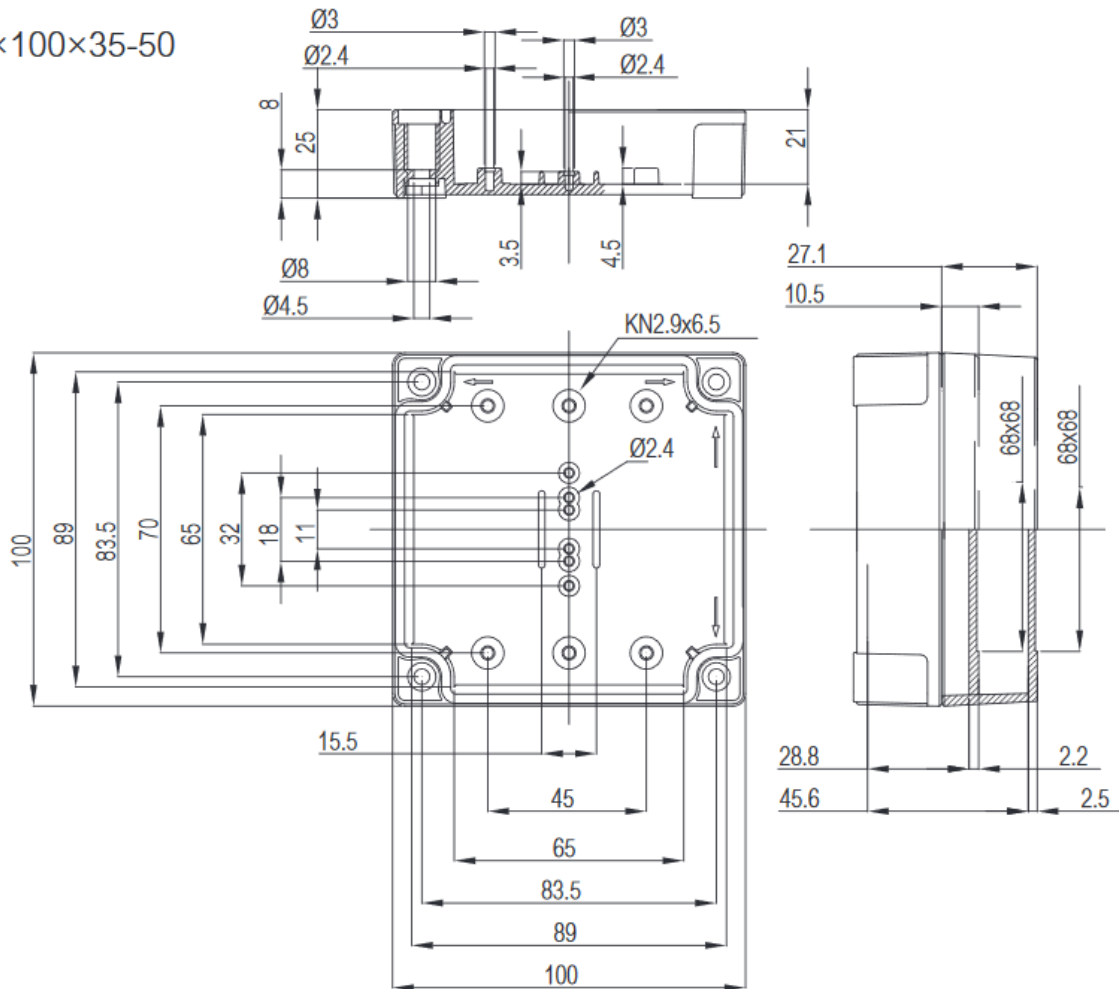

b. Installation

ACW-TCR modems are fixed to a flat wall using the 4 fixing holes available at each corner of the case.

Install the modem at a minimum height of 2m and not glued to the wall, ideally offset at least 20cm. Cables must not exceed 10m in length and must be shielded.

For best results, it is advisable to place it high up and free from any metallic obstacle within a radius of 1 meter if possible (see figures below). For information, the antenna is integrated into the box.

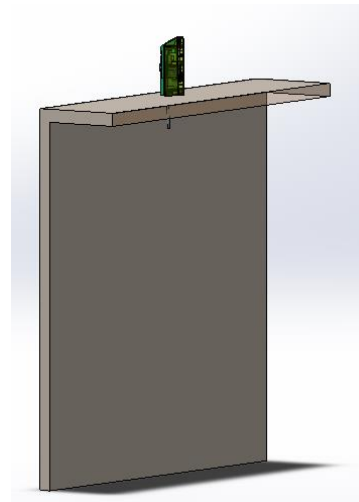
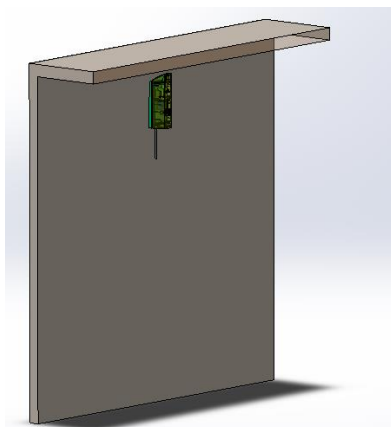
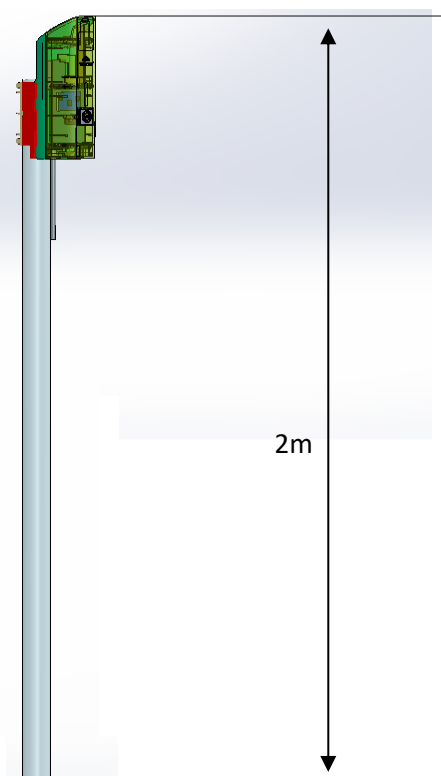

c. Identification

The Sigfox or LoRaWAN product identifier is visible on the exterior label on the back of the device, on the electronic card inside and in the status bar in the ACW configuration tool.

For LoRaWAN modems, the communication keys are automatically provided by the network (pairing via 'Over The Air Activation', or OTAA).

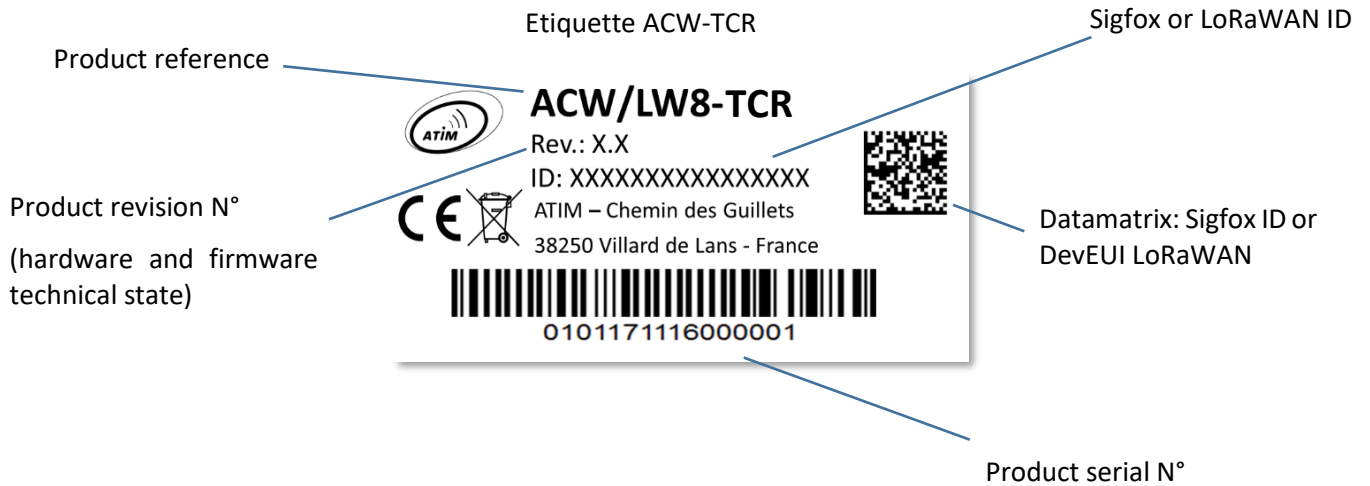

Operating

a. Operating mode

The operating of the ACW-TCR deals with several modes:





- **Exploitation mode:** this is the default mode when starting the product. In this mode, the module periodically sends measurements according to the configuration applied (if the product has never been configured, the factory configuration applies, cf. [Factory settings](#)).
- **Deep sleep mode:** this standby mode mainly allows the product to be put to sleep from the moment the product is powered on until it is installed on site. In this mode, no measurement or radio communication function is possible.
- **Confirmation mode:** this mode is active FIVE minutes after exiting deep sleep mode and allows configuration of the product in **Bluetooth** using the PC configurator. In addition, radio frames are sent every minute (therefore five frames) to ensure that the product is properly commissioned. After these five minutes, the product returns to operating mode and **Bluetooth** is deactivated (possibility of reactivating it via **Downlink**).
- **Pairing mode:** this mode is active after exiting deep sleep mode and allows to pair to the network.
- **Fault mode:** This mode allows the normal operation of the module to be interrupted when a critical event occurs. The nature of the event can be multiple:
 - Empty battery (battery voltage less than 2.2V)
 - Error on the radio module
 - Error when automated tests
 - Error in the application

Entering Fault mode is indicated by a flashing **RED** LED of the product.

If the error does not come from the radio module, the product will send 3 radio frames every 24 hours containing the error code (s) (see chapter [Frames format](#) for error codes). In addition, the product will emit luminous warning depending on the nature of the event.

Once in this mode, the module must be restarted (by disconnecting and reconnecting the battery or by command in Downlink) to return to its normal operation.

At any time, it is possible to identify which mode the product is in by bringing a magnet close **at least for 2 seconds** to the diamond mark on the case. The product led will light up in one of these colours depending on the mode:

-  for operating mode
-  for configuration mode
-  for deep sleep mode
-  for fault mode
-  for pairing mode

b. Product start up

In most cases, the ACW-TCR is started up before delivery (battery packs already connected) and then placed in deep sleep mode to limit consumption.

To place the product in its operating mode, bring a magnet close to the diamond-shaped marking on the box for 6 seconds. During these **6 seconds**, the product LED should flash **WHITE** and then **GREEN** after six seconds to indicate that the product has started up.

The ACW then enters the network pairing phase. During this phase, a **FUSCHIA** light signal with a fading effect indicates that the search phase is in progress.

If the connection is successful, the product will emit a light signal depending on the quality of the network:

- **GREEN** light signal: good quality of network
- **YELLOW** light signal: low quality of network
- **ORANGE** light signal: bad quality of network
- **WHITE** light signal: no information on the quality of the network

The module will then enter its operating mode and start to send information to the network depending on the configuration.

Particular Case

- For a Sigfox device
 - For information on the quality of the Sigfox or LoRaWAN network, it is necessary to provision a Downlink. It is this one which will make it possible to decide on the quality of the network. The product emits at startup (directly for Sigfox after the Join phase for LoRaWAN), a test Uplink described in the chapter [Classic frame](#) (frame type 0x02). If a Downlink is provisioned, the information on network quality will then be relayed by the ACW (light signal). If no Downlink is provisioned, the ACW will always display a **WHITE** light signal.
 - If a **WHITE** light signal at the end of 5 minutes of the pairing phase is emitted by the product **AND** a Downlink has been provisioned, this therefore means that the Network is not accessible.
 - If a **WHITE** light signal at the end of the 5min pairing phase is emitted by the product **WITHOUT** a Downlink having been provisioned, this has no meaning for the quality of the network. The quality of the network can be good as well as bad (or nonexistent).
- For a LoRaWAN device
 - In the default **LoRaWan Class A** operating mode, (see chapter Radio Parameters), if at the end of the 5 minutes of the pairing phase, no network has been reached, then the product goes into standby and will restart a pairing phase of 5 minutes 24 hours later. So, if the product is placed in an area not yet covered by a network, the product will join it when connectivity is possible. There is no need to intervene on the product for it to join the network.
 - In the **LoRa / LoRaWan Repeater Compatibility** operating mode, (see chapter Radio Parameters), if at the end of the 5 minutes of the pairing phase, no network has been reached, then the product emits a **WHITE** light signal and enters its nominal operating mode. Even if no network has been reached, it is assumed with this mode that an ATIM LoRa / LoRaWan repeater located nearby will be able to repeat the Local frames sent by the product in LoRaWan frame on the network that the repeater will have joined.

c. Test frame emission

When the product is in its operating mode (and only in this mode), it is possible to send a test frame (which avoids waiting for the next measurement frame) including a measurement sample.

To do this, simply bring the magnet closer until the **GREEN** light signal goes out. The successful sending of the test frame will be indicated by a **CYAN** light signal.

d. Deep sleep entry

While transporting or storing the ACW-TCR, it is best to place it in its deep sleep mode to limit unnecessary energy consumption.

From any operating mode (except fault mode), bring a magnet near the diamond marking on the box for **6 seconds**.

During these six seconds, the LED of the product will flash in the colour corresponding to the operating mode then the end of the sequence will be indicated by a **WHITE** fade acknowledging that the product has been put on standby. The magnet can therefore be removed.

e. Radio module activity

Any sending of a radio frame is indicated by three brief **GREEN** flashes of the LED.

f. Threshold exceeded

When thresholds have been configured using the configurator and the measurement values exceed these thresholds, the product LED emits a periodic **ORANGE** flash to notify it.

g. Anti-fraud system

A mechanism (push button) is present on the product to notify any opening of the case during normal operation.

Normally, the box exerts pressure on the button. As soon as the back cover is removed, the button is released, triggering an alert. A light signal indicates that the opening of the case has been considered.

In addition, if the module is connected to a network, an alarm frame will be sent immediately when the box is opened and then closed.

h. Substitution to the magnet

You can use the push button on the ACW-TCR card to perform the same actions as the magnet (activate or standby the product, activate / deactivate Bluetooth).

To do this, open the box and press the push button twice at the same time. A white flash indicates that the button now acts as the magnet (**button pressed = magnet approached**, refer to the chapters [Product Start up](#), [Sending a test frame](#) and [Deep sleep setup](#) above to know how to use the button).

<p>WARNING: Once the operations are complete, press the button twice again to restore it to its main function. A white flash indicates that the manipulation was successful.</p>

i. Battery passivation

The ACW-TCR incorporates a battery depassivation feature, to limit the phenomenon of battery passivation during prolonged phases of deep standby. This feature is automatically activated as soon as the product goes into its deep sleep mode. The product will then wake up once a day to start the battery depassivation sequence, then the product will automatically return to deep standby.

ACW configurator

a. Compatible configurator version

For a TCR with the following application software version	Use the version of ACW Configurator
Sigfox: V0.0.1 LoRaWAN: V0.0.1	V5.1.0 or greater

Download and install the configuration software setup “setupACW.exe” at:

<https://www.atim.com/en/downloading/>

Notes: The device must be in **Configuration mode** before being detectable from the ACW Configurator APP, even if USB is used. To enter configuration mode from any mode, the product must enter deep sleep mode first (bring magnet 6 seconds until the led flashes white), and then exit deep sleep (bring magnet 6 seconds again until the led flashes green).

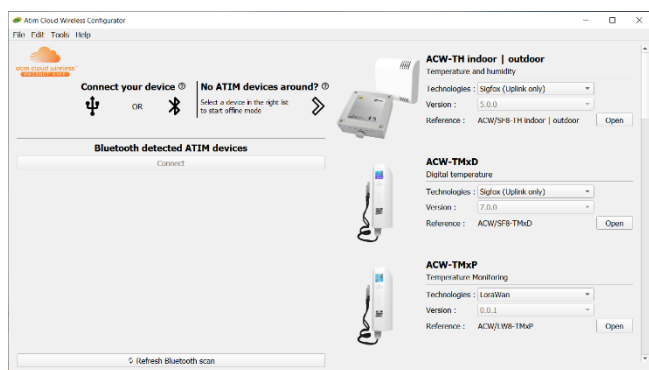

When the ACW Configurator is launched, the waiting window appears on the screen.

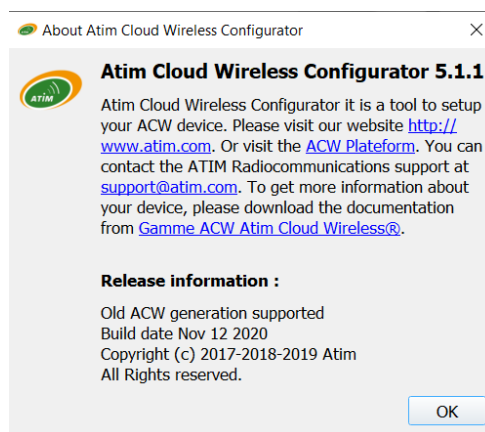

Click on "Help" at the top left of the window then on "About" to display the version number of the ACW configurator.

Pairing the ACW-TCR with the configurator can be done in two ways:

- **Through USB:** open the case of the ACW-TCR and connect it to a computer with a micro-USB cable.
- **Through Bluetooth:** make sure that Bluetooth is activated



Do not leave the product connected to the configurator (via USB or Bluetooth) unnecessarily, otherwise the autonomy of the product will be seriously degraded.

b. Configuration du ACW-TCR

Atim Cloud Wireless Configurator

File Edit Tools Help

ACW/LWS-TCR

Digital Cold Room temperature

LoraWan

Datalogging

Periods

1 Statement 0 H 4 Min

Sampling 0h 4m 0s

Samples and Redundancy

Number of samples 1 2

Depth of historic 1 3

Err: Didn't have way. Call wayAdd()

General settings

Keep alive period Disable 4

Timestamp Disable 5

Radio Settings 6

Radio Mode LoRaWan

LoRaWan Class Class A

Radio Channel

Time Settings 7

No Date

0 Date Offset (in sec)

Temperature configuration 9

Virtual Sensor thermal inertia 2

The Virtual Temperature is calculated using the average of the last 2 Digital Value.

Digital Sensor Enabled

Virtual Sensor Enabled

Threshold

High 0,2 °C

Low 0,0 °C

Hysteresis +/- 0,1 °C

Duration 1 s

Fast TX period 4 min

Threshold

High 0,2 °C

Low 0,0 °C

Hysteresis +/- 0,1 °C

Duration 1 s

Fast TX period 4 min

Threshold

High 0,2 %RH

Low 0,0 %RH

Hysteresis +/- 0,1 %RH

Duration 1 s

Fast TX period 4 min

Threshold

High 0,2 %RH

Low 0,0 %RH

Hysteresis +/- 0,1 %RH

Duration 1 s

Fast TX period 4 min

Temperature calibration

offset 0,00

coefficient 0,000

last T°C measured --

last Humidity measured --

10 Close Reload from file Save to file

ACW-TCR:0.0.1 | ARM-N8LW:XXXX 8

Emission period and samples in the frame

The transmission period (1) corresponds to the time interval between each sending of a measurement frame. This period can be configured from 10 min to 255 h and its default value is 1 hour.

In addition, it is possible to configure the number of samples in a frame (2). Thus, several measurements will be carried out before the sending of the frame which will contain all these measurements.

For example, with a period of 12 minutes and several samples of 4, a measurement will be made every 3 minutes and the 4 samples will be sent in a single frame every 12 minutes.

Finally, it is possible to apply a redundancy of the data (3), which means that samples having been sent in the frame n-1, n-2 or n-3 could be sent again in the frame n to the continuation of the new measurement samples (the most recent sample first in the frame and the least recent last).

For example, for a history depth of 3, data from the last 2 frames will be sent, in addition to the new data, in the next frame.

Keep alive frame period

A life frame can be sent periodically (4). This frame will contain the supply voltage of the product.

The value of this period can be configured from 1 hour to 1 month. By default, the value is set to 4 days.

Frame timestamp

It is possible to enable / disable the timestamp in all radio frames (5).

WARNING: This option when activated monopolizes 4 bytes in the frame which cannot be used for useful data.

Radio parameter

The device can work in 3 different operating modes (6):

- For a LoRaWAN device:

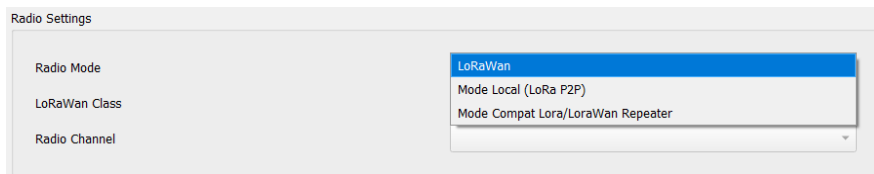

- **LoRAWAN Class A** (default): The product is modulated in LoRa and uses the LoRAWAN Class A protocol. This is the product's default mode. This mode requires a private LoRAWAN network (private gateway), or an operated network to view the data sent by the product.
- **Local mode** : Product modulation remains LoRa modulation. However, there is no LoRAWAN overlay. In this mode, you must choose the radio channel on which the product will transmit. To be able to receive the product frames, a radio modem with the same parameters is then required. This mode has no real concrete use case for the moment, but future developments of this mode will provide interesting point-to-point features.
- **Compatibility mode with the ATIM LoRa / LoRAWAN Repeater**: This mode should be selected when you want to operate in classic LoRAWAN, but no network (private or operated) is accessible. This mode, associated with the ATIM LoRa / LoRAWAN Repeater, then makes it possible to join the LoRAWAN network through this repeater. In this mode, if the network is not joined (no JOIN_ACCEPT), then the product will send its frames locally. The LoRa / LoRAWAN repeater then relays these frames on the network that it has joined (the repeater must be placed at a location with connectivity to the desired network).

Important note: If the product has access to the LoRAWAN network, the default operating mode (LoRaWAN Class A) must be used. If this mode is chosen, while the network is accessible, the product will still send a frame over the LoRAWAN network and this same frame in Local mode to the Repeater, which will consume battery unnecessarily.

- For a Sigfox device:

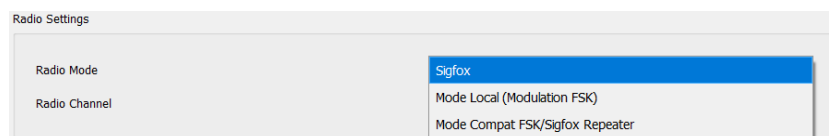

- **Sigfox** (default): Modulation and Sigfox Protocol used. This is the product's default mode. This mode requires access to the Sigfox network to operate.
- **Local mode**: The modulation of the frames switches to FSK. In this mode, you must choose the radio channel on which the product will transmit. To be able to receive the product frames, a radio modem with the same parameters is then required. This mode has no real concrete use case for the moment, but future developments of this mode will provide interesting point-to-point features.

- **Compatibility mode with the ATIM FSK / Sigfox Repeater:** This mode should be selected when you want to operate in Sigfox, but the network is not accessible. This mode, associated with the ATIM FSK / Sigfox Repeater, then makes it possible to join the Sigfox network through this repeater. In this mode, the product transmits these frames both on the Sigfox network and in Local (FSK modulation). The FSK / Sigfox repeater then relays these frames on the Sigfox network (The repeater must be placed in a location where the Sigfox network is accessible).

Important note: If the product has access to the Sigfox network, the default operating mode (Sigfox) must be used. If this mode is chosen, the product will always send a frame on the Sigfox network and this same frame in Local mode to the Repeater, which will consume battery unnecessarily.

Product's clock

Each time you connect to the configurator, the product clock is updated (based on the computer clock) and displayed (7). In addition, an offset in seconds can be applied if needed.

Versions of the product

When connecting to the product, the configurator retrieves all the software versions of the product (product software and radio module software) as well as the network identifier (8).

Sensor's configuration

On ACW-TCR, only a single Temperature/Humidity can be connected. However, the interesting part of the ACW-TCR lie in the possibility to activate a virtual probe which apply an inertial coefficient to the measurement returned by the physical probe.

In deep, the virtual probe's values are calculated by averaging the x last values from the physical probe.

According to this, the parameters are (9):

- Enabling and disabling both virtual and physical probes.
- The value of the inertial coefficient representing how many physical probe's measurement are considered to calculate the value of the virtual probe.

Example

If inertial coefficient is equal to 5, the virtual probe value will be the average of the last 5 physical probe's measurements.

In addition, a threshold detection can be activated on each probe to detect a high or low threshold according to a configurable hysteresis and duration of overrun. When a measurement reaches a threshold, a radio frame will be sent (see the [Alert Frame](#) chapter for details on the frame format).

Validation the configuration

After having filled all the configuration parameters, it is imperative to click on the button "Apply to ACW" to send the configuration to the product (10).

It is also possible at any time to read the current configuration of the product which will update the parameters on the configurator or to reset the default configuration of the product.

c. Factory settings

Radio frame settings

- Emission period of a radio frame: 10 minutes
- Number of samplings: 1
- History depth: 1

General settings

- Emission period of the keep alive frame: 4 days
- Timestamp: disabled
- Radio parameters: LoRaWAN Class A (for a LoRAWAN product) / Sigfox (For a Sigfox product)

Sensor's configuration

Probe 1 (physical)

- State: enabled
- Threshold: disabled

Probe 2 (virtual):

- State: enabled
- Inertial coefficient: 5
- Threshold: disabled

d. Update ACWs

When connected with Bluetooth Low Energy to the product, it is possible to update the different software that composes it.

To do this, go to the menu Tools->Updater (CTRL+U)

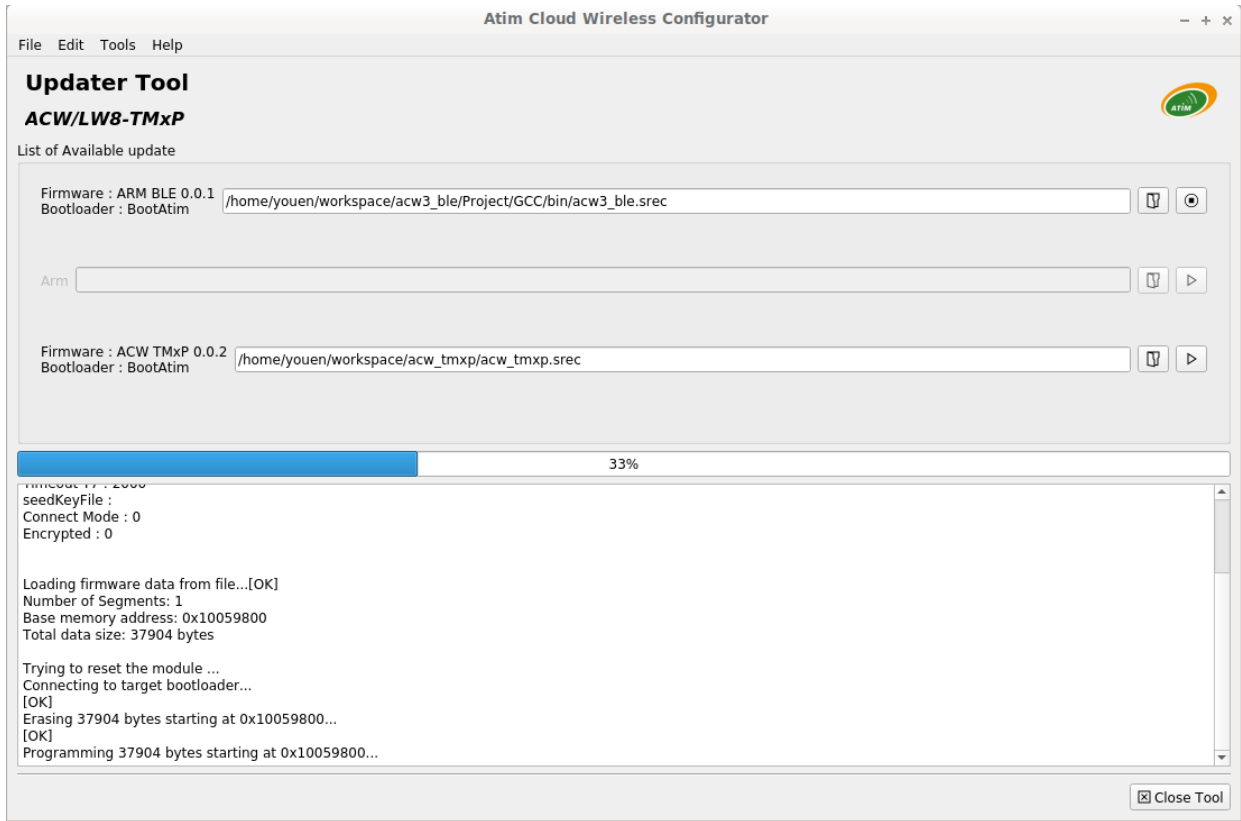

Frames' format

a. Sigfox & LoRaWAN

Uplink frame			
Byte 1	Byte 2	...	Byte n
Frame header	Frame specific data		

We can differentiate three types of frames:

- **Classic frame; New generation:** Very similar to the old frames, the difference is that you can activate the timestamp. These are for example the life frame, the error frame, the response to configuration frames, ... These last frames are common to all ACWs but, it is also possible to have other independent frames for each ACWs.
- **Measuring frame; New generation:** These frames consist of samples of the different values of each of the channels that an ACW can read. Beforehand, the number of samples and the depth of the history will be inserted in the header.

Notes: The number of samples and the depth of the history are in common for all the channels of the frame.

- **Alert frame (threshold crossing); New generation:** These frames combine a conventional frame and a measurement frame. They consist of a header warning that a threshold has been exceeded, followed by samples of each of the channels for which a threshold has been exceeded.

Classic frame

Byte 1 - header							
Bit 7	Bit 6	Bit 5	Bit 4	Bit 3	Bit 2	Bit 1	Bit 0
New generation= 1	Timestamp = 1 - enabled 0 - disabled	Measuring frame= 0	Reserved= 0	Type of frame			

If the Timestamp is activated, 4 bytes with the Timestamp value will be preceded by the header (byte 1).

The different type of frames

Type of frame	Data size	Descriptions
0x00	--	Reserved
0x01	4 bytes	Keep alive frame
0x02	0 bytes	Downlink request for network testing
0x03	--	Reserved
0x04	--	Reserved
0x05	1 byte	Teste frame with counter
0x06	Variable	(Cfg box) Answer to a configuration frame
0x07	Variable	(Cfg box) Answer to a command frame
0x08	Variable	(Cfg box) Answer to an error frame
0x09	--	Reserved
0x0a	--	Reserved
0x0b	--	Reserved
0x0c	--	Reserved
0x0d	Variable	Alert measurement frame (threshold crossing or return to normal), followed by the sample of each of the alert channels
0x0e	TBD	General error - TBD (memory, ...)
0x0f	Variable ...	Subframe for ACW. In function of the ACW product

Measuring frame

Byte 1 - Header							
Bit7	Bit6	Bit5	Bit4	Bit3	Bit2	Bit1	Bit0
New generation= 1	Timestamp	Measuring frame= 1	Depth of history (-1) Max: 4		Number of samplings (-1) Max: 8		

If the Timestamp is enabled, 4 bytes with the Timestamp value will be preceded by the header (byte 1).

WARNING: if Depth of history or Number of samplings is greater than 1, the frame emission period will be added after header (byte 1) on two bytes (Little Endian encoding, LSB first)

For each channel, a header is inserted below and is constituted as follows:

Channel header							
Bit7	Bit6	Bit5	Bit4	Bit3	Bit2	Bit1	Bit0
Reserved= 0		Number of the channel		Type of measure			

The possible measure types are:

Measure type	Units	Data size	Data type	Description
0x08	c°C	2 bytes (Big Endian - MSB)	Signed integer	Temperature in hundredth of a degree Celsius <ul style="list-style-type: none"> ➤ Resolution: 0.01°C ➤ Max value: 125°C ➤ Min value: -40°C
0x09	%RH	2 bytes (Big Endian - MSB)	Signed integer	Humidity in hundredth of percentage of relative humidity (%RH) <ul style="list-style-type: none"> ➤ Resolution: 0.01 %RH ➤ Max value: 100 %RH ➤ Min value: 0 %RH

Then follow the data of the measurement sample (s) (depending on the configuration of the product).

Notes: When the frame contains several samples (number of samplings >1 or depth history >1), the samples are sorted from the latest to the oldest.

The number of bytes sent can be determined as follows:

(Size in bytes of the measurement) * (number of samples) * (history depth)

Alert frame

Byte 1 - En-tête							
Bit7	Bit6	Bit5	Bit4	Bit3	Bit2	Bit1	Bit0
New generation= 1	Timestamp	Measuring frame= 0	Reserved= 0	Alert frame = 0x0d			

If the Timestamp is activated, 4 bytes with the Timestamp value will be preceded by the header (byte 1).

For each of the channels in alert, a header is inserted and is constituted as follows:

Channel header							
Bit7	Bit6	Bit5	Bit4	Bit3	Bit2	Bit1	Bit0
Alert type		Number of the channel		Type of measure			

The type of **alert field** is used to identify whether it is a breach of the high threshold, the low threshold or a return between the thresholds.

These values are defined as follows:

Value	Description
0x00	Return in the comfort zone
0x01	Upper threshold crossing
0x02	Lower threshold crossing
0x03	Reserved

The **measurement type** field here is identical to that of the measurement frame (i.e. 0x08 or 0x09 in hexadecimal for the ACW-TCR).

The sample that caused the alert is then inserted afterwards (with **Big Endian** encoding - MSB first).

Keep-alive frame

The life frame is sent at regular intervals according to the configuration applied (by default 4 days) and contains the battery levels of the product when empty (the product does nothing) and when charging (the product is transmitting a frame radio).

Byte 1 - Header							
Bit7	Bit6	Bit5	Bit4	Bit3	Bit2	Bit1	Bit0
New generation = 1	Timestamp = 0	Measurement frame = 0	Reserved = 0	Keep-alive frame = 0x01			

Following this header are 4 bytes, 2 for the empty battery level and 2 for the charging battery level.

The frame is therefore split as follows: 0xAABBBBCCCC

0xAA being the frame header (always equal to 0x81), 0BBBB the empty battery level (value in millivolts, MSB coding) and 0CCCC the charging battery level (value in millivolts, MSB coding)

Example: 0x81 0d24 0c68

0d24: empty battery level = 3364 mV or 3.364 V

0c68: battery charge level = 3176 mV or 3.176 V

Error and alarm generic frame

Byte 1 - Header							
Bit7	Bit6	Bit5	Bit4	Bit3	Bit2	Bit1	Bit0
New generation= 1	Timestamp	Measuring frame= 0	Reserved= 0	Error frame= 0x0e			

If the Timestamp is activated, 4 bytes with the Timestamp value will be preceded by the header (byte 1).

For each error message, a header is inserted and is formed as follows:

Error frame header							
Bit7	Bit6	Bit5	Bit4	Bit3	Bit2	Bit1	Bit0
Message index			Length of the error frame				

The **message index** field is used to prioritize messages when several errors occur.

The **length of the error message** field indicates the size in bytes of the error message.

The following byte identifies the nature of the error that occurred:

Error code	Nature of the error	Description
0x81	ERR_UNKNOWN	
0x82	ERR_BUF_SMALLER	The data table is full, impossible to write any additional data
0x83	ERR_DEPTH_HISTORIC_OUT_OF_RANGE	The history depth is too large or too small for the frame
0x84	ERR_NB_SAMPLE_OUT_OF_RANGE	The number of sampling is too large or too small for the frame
0x85	ERR_NWAY_OUT_OF_RANGE	The number of the channel in the header of the frame is too large or too small
0x86	ERR_TYPEWAY_OUT_OF_RANGE	The type of measurement in the frame header is too large or too small
0x87	ERR_SAMPLING_PERIOD	Bad structure of sampling period
0x88	ERR_SUBTASK_END	End of a sub-task after leaving an infinite loop
0x89	ERR_NULL_POINTER	Pointer with value "NULL"
0x8A	ERR_BATTERY_LEVEL_DEAD	Critical battery level
0x8B	ERR_EEPROM	EEPROM is corrupted
0x8C	ERR_ROM	ROM is corrupted
0x8D	ERR_RAM	RAM is corrupted
0x8E	ERR_ARM_INIT_FAIL	Radio module initialization has failed
0x8F	ERR_ARM_BUSY	The module is already busy (possibly not initialized)
0x90	ERR_ARM_BRIDGE_ENABLE	The module is in bridge mode, cannot send data by radio
0x91	ERR_RADIO_QUEUE_FULL	Radio queue is full
0x92	ERR_CFG_BOX_INIT_FAIL	Error during black box initialization
0x93	ERR_KEEP_ALIVE_PERIOD	Wrong keep alive frame structure
0x94	ERR_ENTER_DEEP_SLEEP	The device entered deep sleep mode
0x95	ERR_BATTERY_LEVEL_LOW	Low battery
0x96	ERR_ARM_TRANSMISSION	A transmission has been initiated but an error has occurred
0x97	ERR_ARM_PAYLOAD_BIGGER	Message size is too large for the capacity of the network
0x98	ERR_RADIO_PAIRING_TIMEOUT	Impossibility to pair to a network within the fixed period

0x99	ERR_SENSORS_TIMEOUT	A timeout has been reached out on the sensor
0x9A	ERR_SENSOR_STOP	The sensor did not report a value after reading
0x9B	ERR_SENSORS_FAIL	The sensor has stopped to operate
0x9C	ERR_BOX_OPENED	Casing opening
0x9D	ERR_BOX_CLOSED	Casing closing

Only codes 0x8A and 0x95 are followed by additional data corresponding to the battery level in millivolts. This value is coded in two bytes, the most significant byte first (MSB).

Warning: for codes ranging from 0x81 to 0x92, the product will enter its FAULT mode and will no longer perform its measurement function. For codes ranging from 0x93 to 0x9D, these correspond only to alarms, so the product continues to operate normally.

b. Frames' examples

Measurement frame

With timestamp disabled, no historic and 1 sample:

Byte 1	Byte 2	Byte 3	Byte 4	Byte 5	Byte 6	Byte 7	Byte 8	Byte 9	Byte 10	Byte 11	Byte 12	Byte 13
0xA0 (new generation measurement frame, no history, 1 sample)	0x08 (channel 0, type of measurement: temperature)	0x08	0x85	0x09 (channel 0, type of measurement: humidity)	0x17	0xDE	0x18 (channel 1 virtual, type of measurement: temperature)	0x01	0x2C	0x19 (channel 1 virtual, type of measurement: humidity)	0x21	0x54

- The probe on channel 0 returns 0x0885 (21.81°C) for temperature and 0x17DE (61.10 %RH) for humidity
- The virtual probe (calculated with the values from channel 0) on channel 1 returns 0x012C (3°C) for temperature and 0x2154 (85.32 %RH) for humidity.

Note: This example is valid for LoRaWan devices. In case of Sigfox the frame will be divided in two distinct ones (due to payload limitation from Sigfox).

Now with 2 samples:

Byte 1	Byte 2 - 3	Byte 4	Byte 5	Byte 6	Byte 7	Byte 8	Byte 9	Byte 10	Byte 11	Byte 12	Byte 13	Byte 14	Byte 15	Byte 16	Byte 17	Byte 18	Byte 19	Byte 20	Byte 21	Byte 22	Byte 23
0xA1 (new generation measurement frame, no history, 2 sample)	0x003C (tx period)	0x08 (channel 0, type of measurement: temperature)	0x01	0x2C	0x08	0xA4	0x09 (channel 0, type of measurement: humidity)	0x22	0x13	0x17	0xDE	0x18 (channel 1 virtual, type of measurement: temperature)	0x01	0x38	0x01	0x86	0x19 (channel 1 virtual, type of measurement: humidity)	0x21	0xD9	0x20	0xEE

Bytes 2 and 3 indicate the transmission period, here 60 minutes (so a sample is measured every 30 minutes),

- For channel 0 (physical probe):
 - The first sample is 0x012C (3°C) / 0x2213 (8723 %RH)
 - The second is 0x08A4 (22.12°C) / 0x17DE (61.10 %RH)
- For channel 1 (virtual probe):
 - The first sample is 0x0138 (3.12°C) / 0x21D9 (8665 %RH)
 - The second is 0x0186 (3.9°C) / 0x20EE (8430 %RH)

Alert frame measurement

For a high threshold exceeded on channel 1 (virtual probe), the frame will be:

Byte 1	Byte 2	Byte 3	Byte 4
0x8D (new generation alert frame)	0x58 (high threshold channel 1 exceeded, temperature measurement)	0x02	0xC9

The sample which has triggered the alert is 0x02C9 (7.13 °C)

Downlink

This functionality is available on ACW-TCR fulfilling the following conditions:

	Application software	Radio firmware
SIGFOX version	V0.0.1	V5.9.3.2
LoRaWAN version	V0.0.1	V5.1.1

The operation of the Downlink is explained in the document ATIM_ACW-DLConfig_UG_EN_v1.4, relating to version V1.2.0 of the ATIM Downlink Protocol (see this document for all parameters and commands common to all products).

The parameters specific to ACW-TCR are as follows:

a. Configuration of the frame parameters (sending period, number of samples, etc.)

Parameter code (Byte 1)	Payload Length (Byte 2)	Parameter index (Byte 3)	Parameter value (Byte 2)	Parameter value (Byte 3)	Parameter value (Byte 4)
0xD4	0x04	0x00	0b00YYZZZ	0xYY	0xZZ

For byte 4, the two bits YY correspond to the history depth (max = 3) and the three bits ZZZ correspond to the number of samples per frame (max = 7)

Bytes 5 and 6 correspond to the period for sending a frame (= 0xYYZZ) ranging from 1 minute to 255 hours (15,300 minutes).

Example: Byte 4 = 0x13

4 samples per frame + addition of the four samples sent to the previous frame.

Byte 5 = 0x02 and byte 6 = 0x54

Tx period = 0x0254 = 596 minutes

b. Virtual probe configuration

Parameter code(Byte 1)	Parameter value (Byte 2)
0x1B	[0x02 .. 0x0A] : Number of values from physical probe considered for the averaging.

Example: Byte2 = 5. If inertial coefficient is equal to 5, the virtual probe value will be the average of the last 5 physical probe's measurements.

c. Number of probes

Parameter code(Byte 1)	Parameter value (Byte 2)
0x17	0x00 = No probes enabled
	0x01 = only physical probe is enabled
	0x11 = both probes are enabled

Note: The value 0x10 is not possible because the virtual probe requires value from physical probe.

d. Threshold configuration

Parameter code(Byte 1)	Byte 2	Byte 3	Byte 4	Byte 5	Byte 6	Byte 7	Byte 8
0xD5 (temperature threshold probe 1)	Upper threshold value		Lower threshold value		Hysteresis		Length
0xD6 (temperature threshold probe 2)							
0xD7 (humidity threshold probe 1)							
0xD8 (humidity threshold probe 2)							

High threshold value field: temperature in hundredths of ° C triggering the high threshold (**Big Endian** encoding)

Low threshold value field: temperature in hundredths of ° C triggering the low threshold (**Big Endian** encoding)

Hysteresis field: margin of uncertainty for thresholds in hundredths of ° C (**Big Endian** encoding)

Duration field: minimum waiting time before triggering the alert after threshold is exceeded

e. Reserved codes for futures evolutions

Parameter code (Byte 1)	Parameter value (Byte 2)
0x10	0x08
0x11	0x00

WARNING: DO NOT CHANGE THESE VALUES

Technical support

Contact our technical support team by email with any questions or technical problems you may have:

<https://www.atim.com/en/technical-support/>